

QCX212 overview

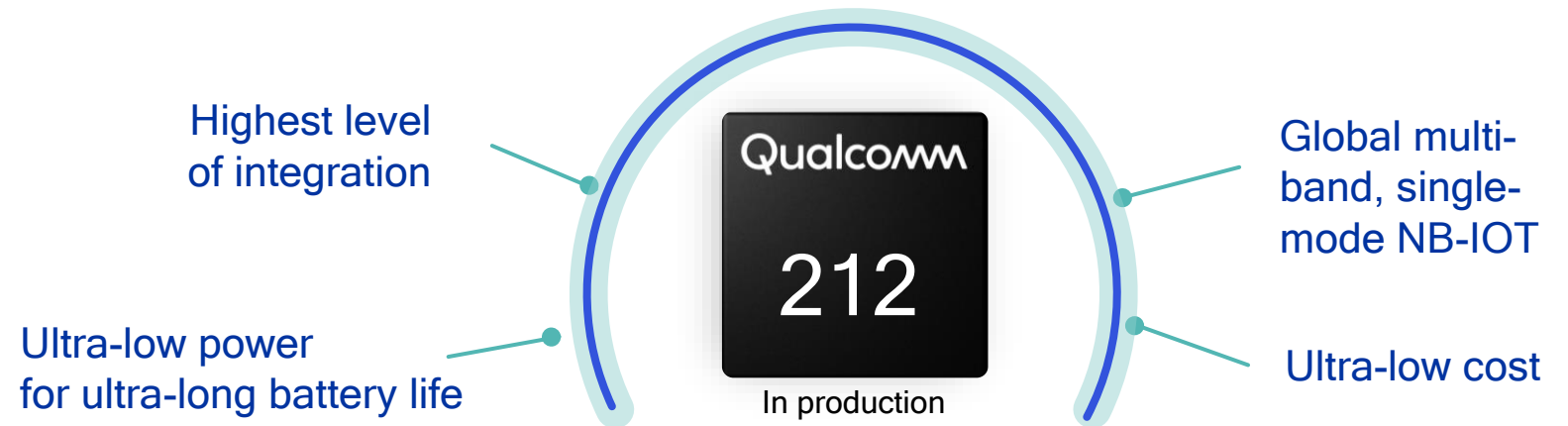
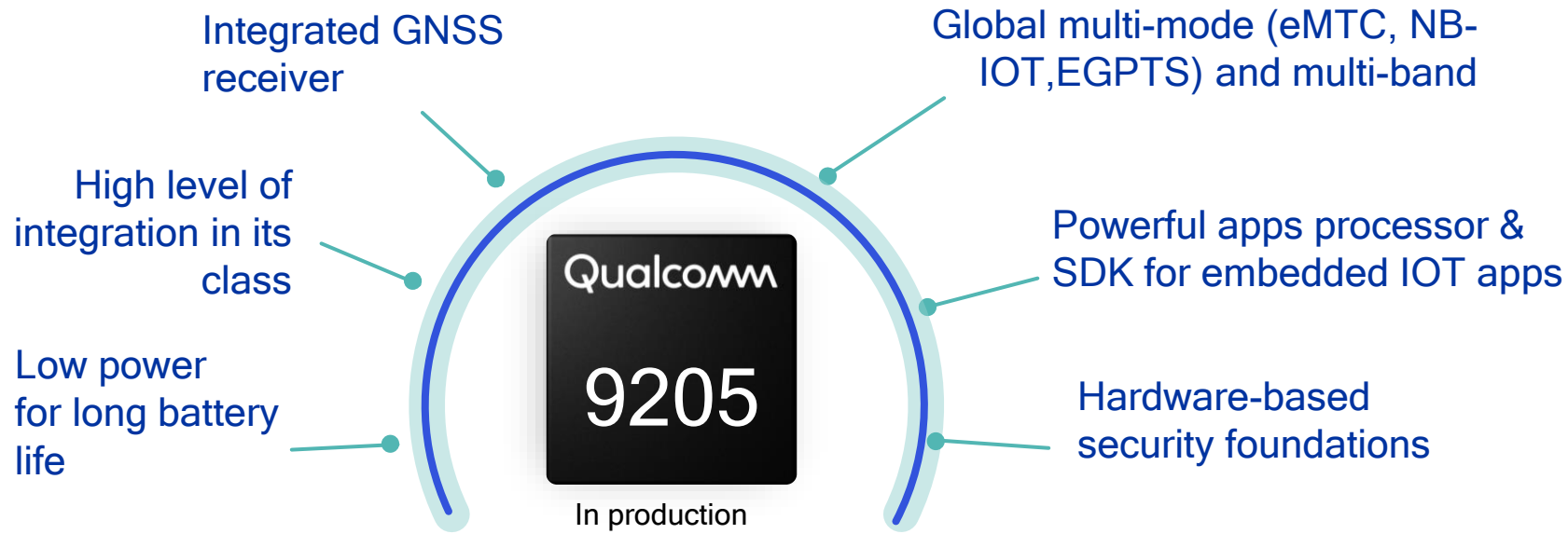

9205 & 212 ... complementary and purpose built for IoT

QCX212 Architecture & capabilities

- 118-PIN TFBGA 5.7*5.7mm package
- Extended coverage and delay tolerance of Rel.14 LTE Cat.NB2 (NB-IoT)
- RF frequency support from 700MHz to 2.1GHz for global NB-IOT roaming
- Ultra-low 2.2V cutoff voltage to support widest range of batteries
- Total of 32 only components in BOM for ultra-low cost
- Ultra-low power with sub 1uA sleep current
- Compact single-chip solution enabling ~100sqmm modules
- Cortex M3 processor @ 204MHz for thin embedded applications
- Complete set of IoT networking protocols

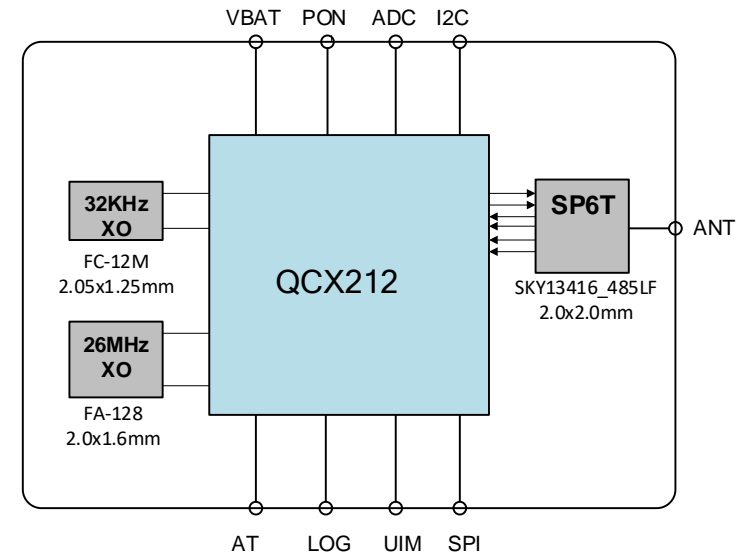
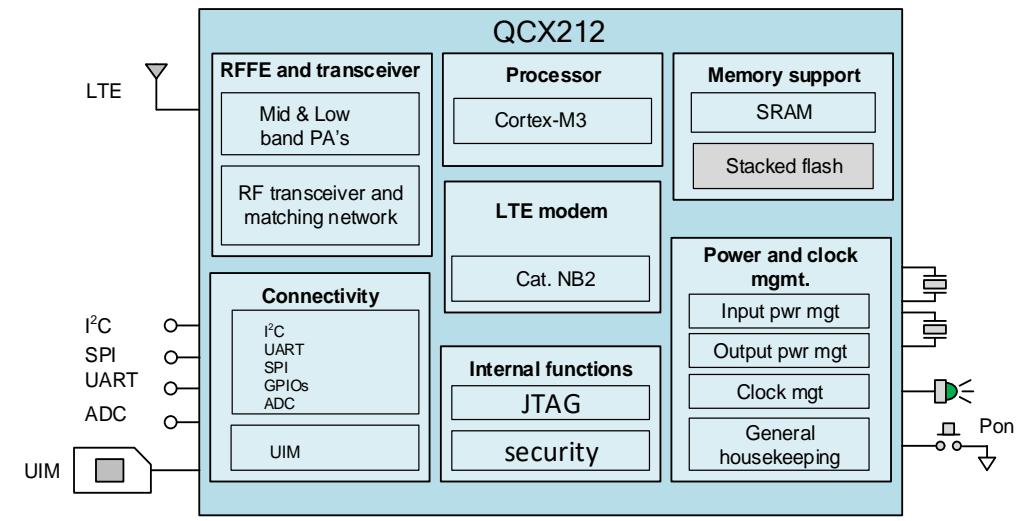

212 ... ultra-compact, ultra-low power, ultra-low cost

Qualcomm 212 modem compared to Qualcomm 9205 modem

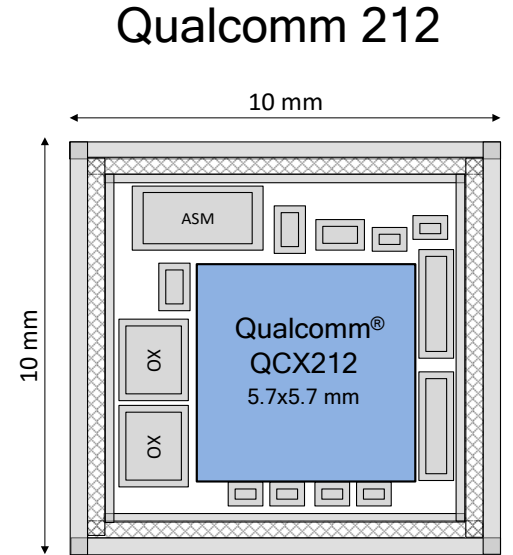
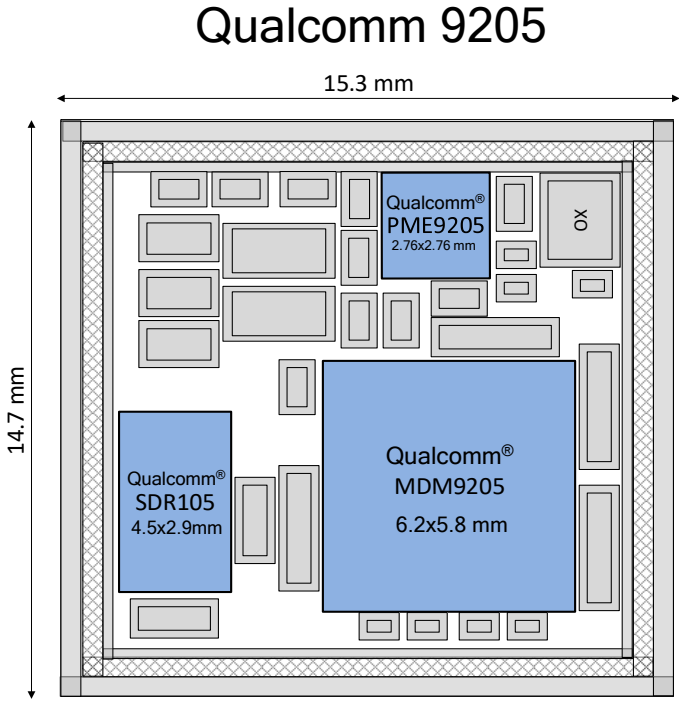
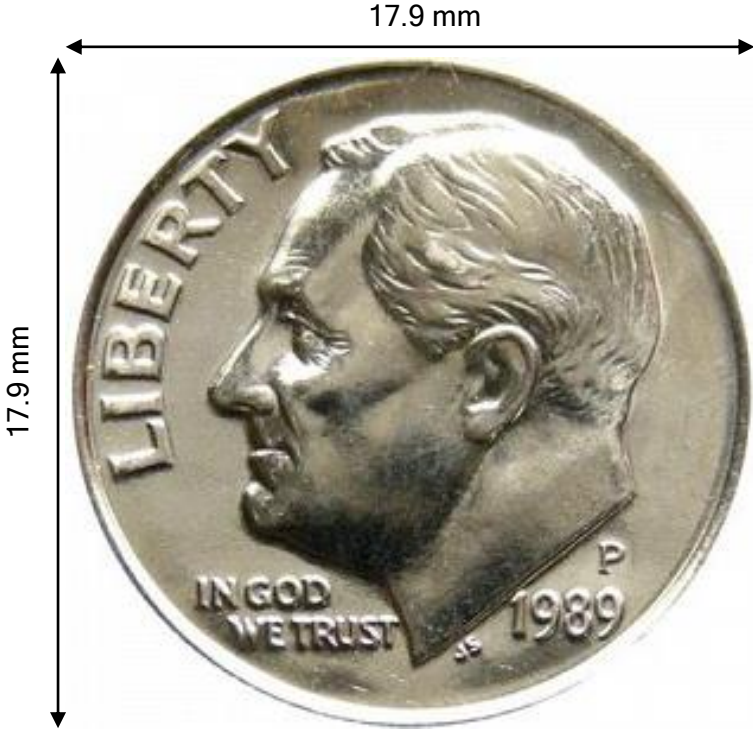

The highest integration level in the LPWAN category.
QCX 212 enables LTE modules below 100 square millimeters in size.

Complimentary and purpose built for IoT

- Low power for long battery life
- Integrated memory and RF front end components enabling modules around 225 sq mm
- Powerful integrated Cortex A7 processor @ 800MHz
- Integrated GNSS receiver
- Global multi-mode (eMTC, NB-IoT, EGPRS) and multi-band
- LTE IoT SDK for embedded IoT apps
- Hardware-based security foundations

Qualcomm
9205
modem

Available today

Qualcomm
212 LTE IoT
modem

Commercial sample
expected
Q3/Q4 2020

- Ultra low power for ultra long battery life
- Highest level of integration in their class* - compact single-chip solution enabling sub 100sqmm modules
- Integrated Cortex M3 processor @ 204MHz for thin embedded applications
- Global single mode (NB-IoT) and multi-band
- Comprehensive set of IoT networking protocols

*Among IoT devices in the LPWA category

QCX212 SW data network components

Network components	Feature
IP stack	IPv4/v6, TCP, UDP, DNS, SOCKET
LightWeightM2M	LWM2M v1.0 client (upgrade to v1.1 in planning)
MQTT	MQTT 3.1.1 client
HTTP(S)	HTTP1.1 client (POST/GET/PUT/DELETE)
COAP	COAP/COAPs client, RFC 7252
TLS	DTLS/TLS1.2 (upgrade to TLS/DTLS v1.3 in planning)
JSON	cJSON
Location	GTP

Security features summary



		MDM9205	QCX212
Secure boot	Secure Boot using RSA2048 and SHA256	✓ + ECC 384 based on SHA384	ECDSA (secp256k1) and SHA256
Secure debug	JTAG disable by e-fuse	✓	✓
HW encryption	GPCE (General Purpose Crypto Engine)	v5.4.X + PKA	Supported algorithms: AES-ECB,CBC (key size 128/192/256), SHA1/224/256 HW key provision for AES via efuse.
	RNG (Random Number Generator)	✓ (v2)	NIST SP800-90B
QTEE	Version	QTEEv5	No Trust Zone Support
	Global Platform APIs	--	
	QSEE Image Integrity	✓	
	Secure File System	✓	
Secure key provisioning		✓	Not Applicable as QTEE is not supported
Certifications	FIPS 140-2	FIPS, DRBG HW Level 1, GPCE HW Level 2	

QCX212 Rel.14 capabilities

Capability	Supported
Rel.14 Cat.NB2 w/ larger TBS and 2 HARQ processes	✓
Rel.14 Cat.NB2 with non-anchor PRB enhancements (multi-carrier NPRACH and Paging)	✓
Rel.14 Cat.NB1/NB2 restrictions on use of coverage enhancement	✓
Rel.14 Cat.NB1/NB2 Release Assistance Indication (RAI)	✓
Rel.14 Cat.NB1/NB2 Introduction of data inactivity timer	✓
Rel.14 Cat.NB1/NB2 RRC Connection Re-establishment for the Control Plane CIoT EPS Optimization	✓
Rel.14 Cat.NB1/NB2 Interference Randomization for the NPDCCH and NPDSCH	✓
Rel.14 NB1/NB2 relaxed monitoring for cell reselection	✓



Thank you!

Follow us on:   

For more information, visit us at:

www.qualcomm.com & www.qualcomm.com/blog

Nothing in these materials is an offer to sell any of the components or devices referenced herein.

©2018 Qualcomm Technologies, Inc. and/or its affiliated companies. All Rights Reserved.

Qualcomm is a trademark of Qualcomm Incorporated, registered in the United States and other countries. Other products and brand names may be trademarks or registered trademarks of their respective owners.

References in this presentation to “Qualcomm” may mean Qualcomm Incorporated, Qualcomm Technologies, Inc., and/or other subsidiaries or business units within the Qualcomm corporate structure, as applicable. Qualcomm Incorporated includes Qualcomm’s licensing business, QTL, and the vast majority of its patent portfolio. Qualcomm Technologies, Inc., a wholly-owned subsidiary of Qualcomm Incorporated, operates, along with its subsidiaries, substantially all of Qualcomm’s engineering, research and development functions, and substantially all of its product and services businesses, including its semiconductor business, QCT.