

Dimensions: [mm]

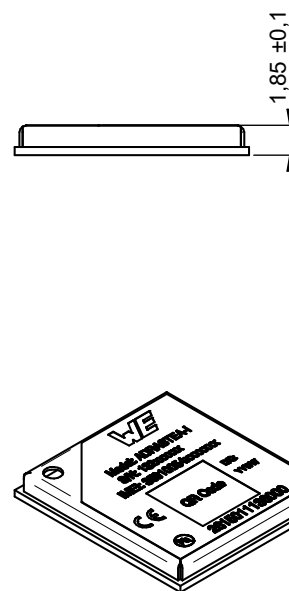

Scale - 2:1

Recommended Hole Pattern: [mm]

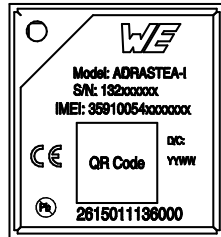
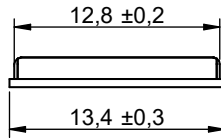
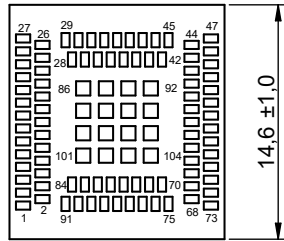
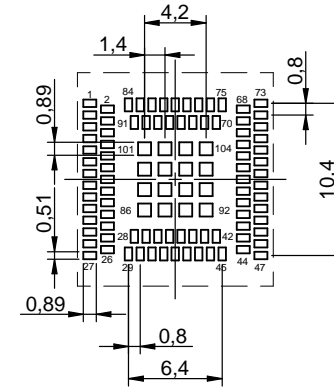

Scale - 2:1

Product Specific Pinning:

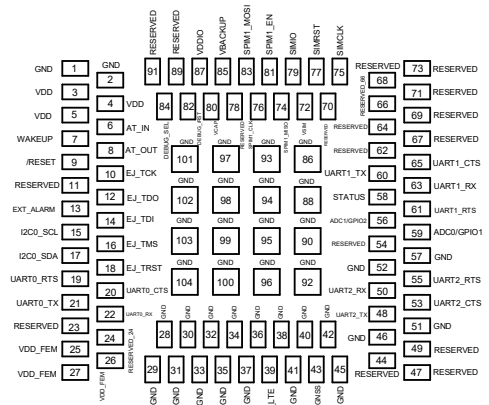

Würth Elektronik eiSos GmbH & Co. KG
EMC & Inductive Solutions
Max-Eyth-Str. 1
74638 Waldenburg
Germany
Tel. +49 (0) 79 42 945 - 0
www.we-online.com
eiSos@we-online.com

CHECKED RaSi	REVISION 001.000	DATE (YYYY-MM-DD) 2022-04-11	GENERAL TOLERANCE DIN ISO 2768-1m	PROJECTION METHOD
DESCRIPTION WIRL-CLTI Adrastea-I LTE-Cat.M and NB-IoT module				ORDER CODE 2615011136000
BUSINESS UNIT eiSmart			STATUS Valid	PAGE 1/8

General Properties:

Properties		Value	Unit
Communication Protocol/Standard	RF _{prot}	LTE Cat.M LTE Cat.NB-IoT	
Antenna Connector Type	ANT _{Conn}	RF pad	
Microcontroller	μC	SoC	
Radio Chipset	RF-IC	Sony Altair - ALT1250	
Communication interface	UART (UART0 for External Host), I2C Master, SPI Master, ADC		
SIM Interface	(U)SIM		
3GPP Release	Release 13 compliant, upgradable to Release 14		
Supported Protocols	IPv4, IPv6, TCP, UDP, HTTP/HTTPS, TLS/DTLS, LWM2M, MQTT		
SMS Support	MT/MO Text SMS, MT/MO PDU SMS		
Positioning and Timing	Integrated GNSS		
Microcontroller Application	ARM Cortex-M4 (For user applications)		
Memory Size (Flash)		1	MB

Electrical Properties:





Properties		Test conditions	Value	Unit
Operating Supply Voltage Min.	V _{DD min.}		2.3	V
Operating Supply Voltage Max.	V _{DD max.}		4.3	V
Recommended Supply Voltage	V _{DD typ}		3.6	V
Operating Supply Voltage Front End Module Min.	V _{DD_FEM min.}		3.1	V
Operating Supply Voltage Front End Module Max.	V _{DD_FEM max.}		4.3	V

Electrical Properties:

Properties		Test conditions	Value	Unit
Recommended Supply Voltage Front End Module	V _{DD_FEM typ.}		3.6	V
Supply Current Sleep	I _{sleep}	DH0, MCU SHUTDOWN, LTE RF Disabled (AT+CFUN=0)	1.57	μA

RF-Electrical Properties:

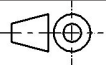
Properties		Test conditions	Value
LTE Bands (LTE Cat.M)	B2/B3/B4/B5/B8/B12/B20/B25/B26/B28		
LTE Bands (NB-IoT)	B3/B5/B8/B20/B28		
Maximum Output Power Class	Power Class 3 (23 dBm)		
Rx Sensitivity (LTE Cat.M)	RX _{sens}	Bandwidth: 1.4 MHz	B2: -105 dBm, B3: -106.4 dBm, B4: -106.2 dBm, B5: -106.2 dBm, B8: -107.2 dBm, B12: -105.6 dBm, B20: -106.4, B25: -106.8 dBm, B26: -106.4 dBm, B28: -106 dBm
Rx Sensitivity (NB-IoT)	RX _{sens}		B3: -110 dBm, B5: -110 dBm, B8: -110 dBm, B20: -110, B28: -110 dBm
Current Consumption (LTE Cat.M)		Idle Mode: MCU RUN Peak Current (TX): TX @23dBm, MCU RUN PSM Current (DH1): MCU SHUTDOWN, LTE RF Disabled (AT+CFUN=0) PSM Current (DH2): MCU SHUTDOWN, LTE RF Disabled (AT+CFUN=0) GNSS Active: MCU RUN, LTE RF Disabled (AT+CFUN=0)	Idle Mode: 16.8 mA Peak Current (TX): 454.2 mA PSM Current (DH1): 39.6 μA PSM Current (DH2): 82.2 μA GNSS Active: 53.98 mA

  	CHECKED	REVISION	DATE (YYYY-MM-DD)	GENERAL TOLERANCE	PROJECTION METHOD	
	RaSi	001.000	2022-04-11	DIN ISO 2768-1m		
	DESCRIPTION			ORDER CODE		
	WURL-CLTI Adrastea-I LTE-Cat.M and NB-IoT module			2615011136000		
Würth Elektronik eiSos GmbH & Co. KG EMC & Inductive Solutions Max-Eyth-Str. 1 74638 Waldenburg Germany Tel. +49 (0) 79 42 945 - 0 www.we-online.com eiSos@we-online.com			BUSINESS UNIT	STATUS	PAGE	
			eiSmart	Valid	2/8	

RF-Electrical Properties:

Properties	Test conditions	Value
Current Consumption (NB-IoT)	Idle Mode: MCU RUN	Idle Mode: 15.7 mA
	Peak Current (TX): TX @23dBm, MCU RUN	Peak Current (TX): 434 mA
	PSM Current (DH1): MCU SHUTDOWN, LTE RF Disabled (AT+CFUN=0)	PSM Current (DH1): 38.5 µA
	PSM Current (DH2): MCU SHUTDOWN, LTE RF Disabled (AT+CFUN=0)	PSM Current (DH2): 81.5 µA
RF Data Rate max. (LTE Cat.M)	$R_{b,max}$	Downlink: 300 kbps Uplink: 375 kbps
RF Data Rate max. (NB-IoT)	$R_{b,max}$	Downlink: 27.2 kbps Uplink: 62.5 kbps

GNSS Performances:

Properties	Test conditions	Value	Unit
GNSS Constellations Supported		GPS, GLONASS	
Position Accuracy (GPS & GLO)		1.5	m
Time To First Fix (Cold Start)	GPS-GLONASS, Power Level = -120dBm	36	s
Time To First Fix (Hot Start)	GPS-GLONASS, Power Level = -120dBm	1	s
Rx Sensitivity (Cold Start)	GPS-GLONASS	-145	dBm
Rx Sensitivity (Hot Start)	GPS-GLONASS	-152	dBm
Rx Sensitivity (Tracking)	GPS-GLONASS	-160	dBm

Certification:

RoHS Approval	Compliant [2011/65/EU&2015/863]
REACH Approval	Conform or declared [(EC)1907/2006]

User Microcontroller:





Properties	Value	Unit
Microcontroller for User	µC	ARM Cortex-M4
Memory Size (RAM)		256 kB
Memory Size (Flash)		1 MB

General Information:

Ambient Temperature (referring to I_R)	-40 up to +85 °C
Operating Temperature	-40 up to +85 °C
Storage Conditions (in original packaging)	< 40 °C ; < 90 % RH
Moisture Sensitivity Level (MSL)	3

Product Specific Pinning:

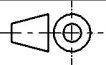
Pin	Pad	Description	I/O
GND	1	Negative supply voltage	Supply
GND	2	Negative supply voltage	Supply
VDD	3	Positive supply voltage (VDD)	Supply
VDD	4	Positive supply voltage (VDD)	Supply
VDD	5	Positive supply voltage (VDD)	Supply
AT_IN	6	Anti-tamper input	Input
WAKEUP	7	Wakeup active high	Input
AT_OUT	8	Anti-tamper output	Output
/RESET	9	Reset active low	Input
EJ_TCK	10	JTAG Test Clock	Input
RESERVED	11	See manual for more details	--
EJ_TDO	12	JTAG Test Data Output	Output
EXT_ALARM	13	Alarm Output	Output
EJ_TDI	14	JTAG Test Data Input	Input





  	CHECKED RaSi	REVISION 001.000	DATE (YYYY-MM-DD) 2022-04-11	GENERAL TOLERANCE DIN ISO 2768-1m	PROJECTION METHOD 
 WÜRTH ELEKTRONIK MORE THAN YOU EXPECT	WÜRTH Elektronik eiSos GmbH & Co. KG EMC & Inductive Solutions Max-Eyth-Str. 1 74638 Waldenburg Germany Tel. +49 (0) 79 42 945 - 0 www.we-online.com eiSos@we-online.com			DESCRIPTION WIRL-CLTI Adrastea-I LTE-Cat.M and NB-IoT module	
	ORDER CODE 2615011136000			BUSINESS UNIT eiSmart	STATUS Valid

Product Specific Pinning:

Pin	Pad	Description	I/O
I2CO_SCL	15	I2C serial clock	Input/Output
EJ_TMS	16	JTAG Test Mode Select	Input
I2CO_SDA	17	I2C serial data	Input/Output
EJ_TRST	18	JTAG Test Reset– required external pull down	Input
UART0_RTS	19	MCU UART0 Request to Send	Output
UART0_CTS	20	MCU UART0 Clear to Send	Input
UART0_TX	21	MCU UART0 Transmit Data	Output
UART0_RX	22	MCU UART0 Receive Data	Input
RESERVED	23	See manual for more details	--
RESERVED	24	See manual for more details	--
VDD_FEM	25	Power supply for FEM (Front End Module)	Supply
VDD_FEM	26	Power supply for FEM (Front End Module)	Supply
VDD_FEM	27	Power supply for FEM (Front End Module)	Supply
GND	28, 29, 30, 31, 32, 33, 34, 35, 36, 37, 38	Negative supply voltage	Supply
RF_LTE	39	RF Signal LTE	RF
GND	40, 41, 42	Negative supply voltage	Supply
RF_GNSS	43	RF Signal GNSS	RF
RESERVED	44	See manual for more details	--
GND	45	Negative supply voltage	Supply
GND	46	Negative supply voltage	Supply
RESERVED	47	See manual for more details	--
UART2_TX	48	UART2 Transmit Data (CLI port)	Output
RESERVED	49	See manual for more details	--
UART2_RX	50	UART2 Receive Data (CLI port)	Input
GND	51	Negative supply voltage	Supply
GND	52	Negative supply voltage	Supply



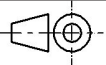

Product Specific Pinning:

Pin	Pad	Description	I/O
UART2_CTS	53	UART2 Clear to Send (CLI port)	Input
RESERVED	54	See manual for more details	--
UART2_RTS	55	UART2 Request to Send (CLI port)	Output
ADC1/GPIO2	56	Auxiliary Analog to Digital Converter Input / Programmable GPIO	Input/Output
GND	57	Negative supply voltage	Supply
STATUS	58	Module Status	Output
ADC0/GPIO1	59	Auxiliary Analog to Digital Converter Input / Programmable GPIO	Input/Output
UART1_TX	60	UART1 Transmit Data (Modem Log port)	Output
UART1_RTS	61	UART1 Request to Send (Modem Log port)	Output
RESERVED	62	See manual for more details	--
UART1_RX	63	UART1 Receive Data (Modem Log port)	Input
RESERVED	64	See manual for more details	--
UART1_CTS	65	UART1 Clear to Send (Modem Log port)	Input
RESERVED	66	See manual for more details	--
RESERVED	67	See manual for more details	--
RESERVED	68	See manual for more details	--
RESERVED	69	See manual for more details	--
RESERVED	70	See manual for more details	--
RESERVED	71	See manual for more details	--
VSIM	72	SIM Output voltage	Output
RESERVED	73	See manual for more details	--
SPIM1_MISO/GPIO39	74	MCU_SPIM1_MISO/Programmable GPIO	Input/Output
SIMCLK	75	SIM Clock	Output
SPIM1_CLK/GPIO41	76	MCU_SPIM1_CLK/Programmable GPIO	Input/Output

  	CHECKED	REVISION	DATE (YYYY-MM-DD)	GENERAL TOLERANCE	PROJECTION METHOD
	RaSi	001.000	2022-04-11	DIN ISO 2768-1m	
 <p>Würth Elektronik eiSos GmbH & Co. KG EMC & Inductive Solutions Max-Eyth-Str. 1 74638 Waldenburg Germany Tel. +49 (0) 79 42 945 - 0 www.we-online.com eiSos@we-online.com</p>	DESCRIPTION			ORDER CODE	
	WURL-CLTI Adrastea-I LTE-Cat.M and NB-IoT module			2615011136000	
	BUSINESS UNIT	STATUS	PAGE		
	eiSmart	Valid	4/8		

Product Specific Pinning:

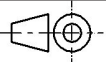
Pin	Pad	Description	I/O
SIMRST	77	SIM Reset	Output
RESERVED	78	See manual for more details	--
SIMIO	79	SIM Data	Input/Output
VCAP	80	Connecting external capacitor as backup for VDD	Input/Output
SPIM1_EN/ GPIO40	81	MCU SPI Enable/Programmable GPIO	Input/Output
DEBUG_/RST	82	Reset pin for the JTAG probe	Input/Output
SPIM1_MOSI/ GPIO38	83	MCU_SPIM1_MOSI/Programmable GPIO	Input/Output
DEBUG_SEL	84	EJTAG chain selection	Input
VBACKUP	85	Input from backup battery	Input
GND	86	Negative supply voltage	Supply
VDDIO	87	Output Voltage	Output
GND	88	Negative supply voltage	Supply
RESERVED	89	See manual for more details	--
GND	90	Negative supply voltage	Supply
RESERVED	91	See manual for more details	--
GND	92, 93, 94, 95, 96, 97, 98, 99, 100, 101, 102, 103,104	Negative supply voltage	Supply

  	CHECKED RaSi	REVISION 001.000	DATE (YYYY-MM-DD) 2022-04-11	GENERAL TOLERANCE DIN ISO 2768-1m	PROJECTION METHOD 	
	DESCRIPTION WIRL-CLTI Adrastea-I LTE-Cat.M and NB-IoT module				ORDER CODE 2615011136000	
 WÜRTH ELEKTRONIK MORE THAN YOU EXPECT	Würth Elektronik eiSos GmbH & Co. KG EMC & Inductive Solutions Max-Eyth-Str. 1 74638 Waldenburg Germany Tel. +49 (0) 79 42 945 - 0 www.we-online.com eiSos@we-online.com			BUSINESS UNIT eiSmart	STATUS Valid	PAGE 5/8
	This electronic component has been designed and developed for usage in general electronic equipment only. This product is not authorized for use in equipment where a higher safety standard and reliability standard is especially required or where a failure of the product is reasonably expected to cause severe personal injury or death, unless the parties have executed an agreement specifically governing such use. Moreover Würth Elektronik eiSos GmbH & Co KG products are neither designed nor intended for use in areas such as military, aerospace, aviation, nuclear control, submarine, transportation (automotive control, train control, ship control), transportation signal, disaster prevention, medical, public information network etc.. Würth Elektronik eiSos GmbH & Co KG must be informed about the intent of such usage before the design-in stage. In addition, sufficient reliability evaluation checks for safety must be performed on every electronic component which is used in electrical circuits that require high safety and reliability functions or performance.					

Packaging Specification - Tape: [mm]

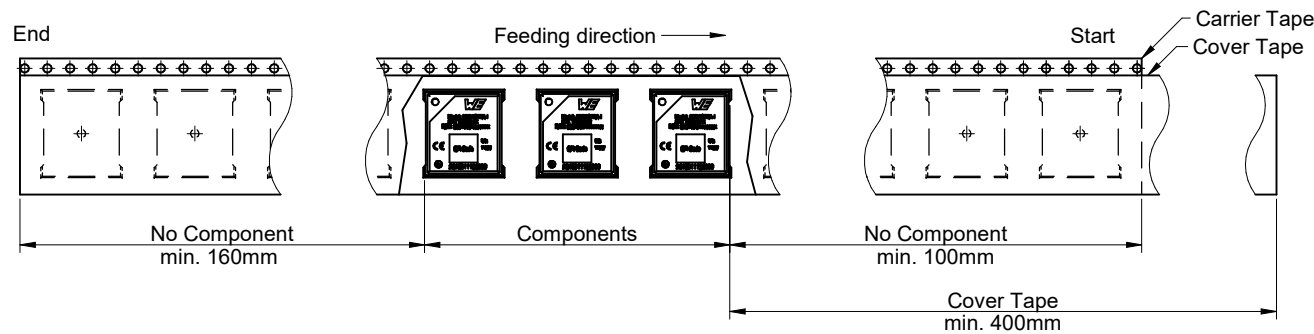
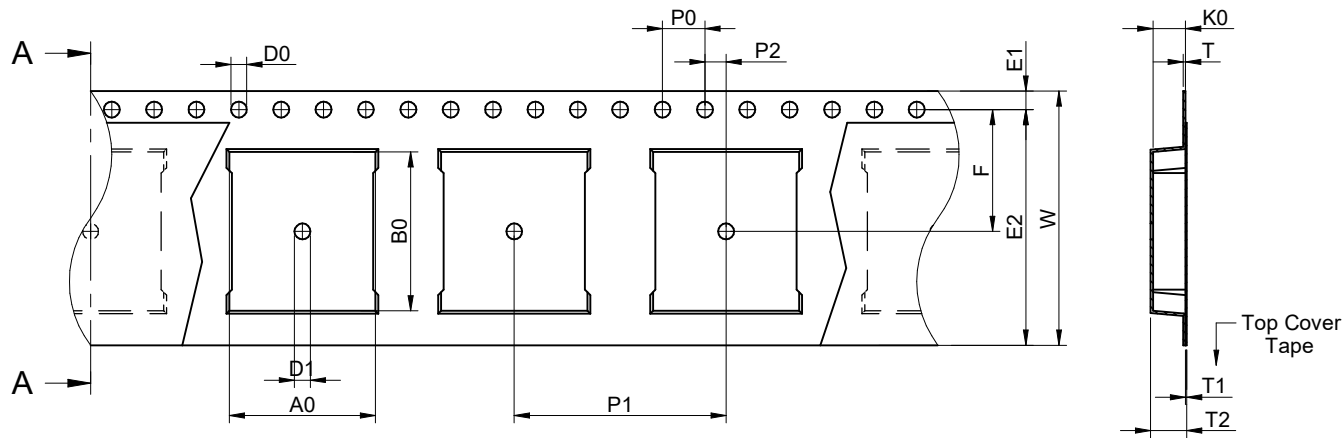

	Tape Type	A0 (mm)	B0 (mm)	W (mm)	T (mm)	T1 (mm)	T2 (mm)	K0 (mm)	P0 (mm)	P1 (mm)	P2 (mm)	D0 (mm)	D1 (mm)	E1 (mm)	E2 (mm)	F (mm)	Material	Qty. (pcs.)
Tolerance		typ.	typ.	+0.3/-0.1	ref.	ref.	typ.	typ.	±0.1	±0.1	±0.1	+0.1/-0.0	min.	±0.1	min.	±0.1	Polystyrene	500
Value	2a	13,80	15,00	24,00	0,40	0,10	3,00	2,50	4,00	20,00	2,00	1,50	1,50	1,75	22,25	11,50	Polystyrene	500

Packaging Specification - Reel: [mm]

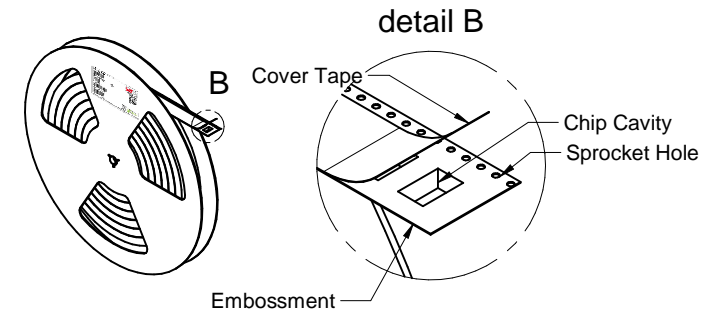
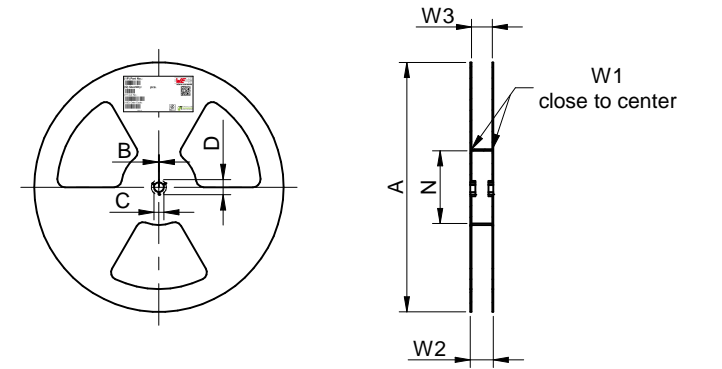

	A (mm)	B (mm)	C (mm)	D (mm)	N (mm)	W1 (mm)	W2 (mm)	W3 (mm)	W3 (mm)	Material
Tolerance	± 2.0	min.	min.	min.	min.	+ 2.0	max.	min.	max.	
Value	330,00	1,50	12,80	20,20	60,00	24,40	30,40	23,90	27,40	Polystyrene

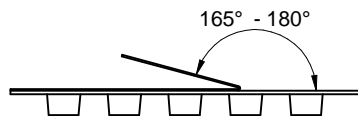

Tape width	24 mm	Pull-of force	0,1 N - 1,3 N
------------	-------	---------------	---------------



Würth Elektronik eiSos GmbH & Co. KG
 EMC & Inductive Solutions
 Max-Eyth-Str. 1
 74638 Waldenburg
 Germany
 Tel. +49 (0) 79 42 945 - 0
 www.we-online.com
 eiSos@we-online.com

CHECKED RaSi	REVISION 001.000	DATE (YYYY-MM-DD) 2022-04-11	GENERAL TOLERANCE DIN ISO 2768-1m	PROJECTION METHOD
DESCRIPTION WIRL-CLTI Adrastea-I LTE-Cat.M and NB-IoT module			ORDER CODE 2615011136000	
BUSINESS UNIT eiSmart		STATUS Valid	PAGE 6/8	

Cautions and Warnings:

The following conditions apply to all goods within the product series of sensor components of Würth Elektronik eiSos GmbH & Co. KG:

General:

- This electronic component is designed and manufactured for use in general electronic equipment.
- Würth Elektronik must be asked for written approval (following the PPAP procedure) before incorporating the components into any equipment in fields such as military, aerospace, aviation, nuclear control, submarine, transportation (automotive control, train control, ship control), transportation signal, disaster prevention, medical, public information network, etc. where higher safety and reliability are especially required and/or if there is the possibility of direct damage or human injury.
- Electronic components that will be used in safety-critical or high-reliability applications, shall be pre-evaluated by the customer.
- The component is designed and manufactured to be used within the datasheet specified values. If the usage and operation conditions specified in the datasheet are not met, the wire insulation may be damaged or dissolved.
- Do not drop or impact the components, the component may be damaged
- Würth Elektronik products are qualified according to international standards, which are listed in each product reliability report. Würth Elektronik does not warrant any customer qualified product characteristics beyond Würth Elektronik's specifications, for its validity and sustainability over time.
- The responsibility for the applicability of the customer specific products and use in a particular customer design is always within the authority of the customer. All technical specifications for standard products also apply to customer specific products.

Product specific:

Soldering:

- The solder profile must comply with the technical product specifications. All other profiles will void the warranty.
- All other soldering methods are at the customers' own risk.

Cleaning and Washing:

- Washing agents used during the production to clean the customer application might damage or change the characteristics of the component. Washing agents may have a negative effect on the long-term functionality of the product.
- Using a brush during the cleaning process may damage the component. Therefore, we do not recommend using a brush during the PCB cleaning process.

Potting and Coating:

- Potting material might shrink or expand during and after hardening. This might apply mechanical stress on the components, which can influence the characteristics of the transfer function. In addition, potting material can close existing openings in the housing. This can lead to a malfunction of the component. Thus, potting is not recommended.

- Conformal coating may affect the product performance. We do not recommend coating the components.

Storage Conditions:

- A storage of Würth Elektronik products for longer than 12 months is not recommended. Within other effects, the terminals may suffer degradation, resulting in bad solderability. Therefore, all products shall be used within the period of 12 months based on the day of shipment.
- Do not expose the components to direct sunlight.
- The storage conditions in the original packaging are defined according to DIN EN 61760-2.
- For a moisture sensitive component, the storage condition in the original packaging is defined according to IPC/JEDEC-J-STD-033. It is also recommended to return the component to the original moisture proof bag and reseal the moisture proof bag again.
- The storage conditions stated in the original packaging apply to the storage time and not to the transportation time of the components.

Packaging:





- The packaging specifications apply only to purchase orders comprising whole packaging units. If the ordered quantity exceeds or is lower than the specified packaging unit, packaging in accordance with the packaging specifications cannot be ensured.

Violation of the technical product specifications such as exceeding the nominal rated supply voltage, will void the warranty.

- Violation of the technical product specifications such as but not limited to exceeding the absolute maximum ratings will void the conformance to regulatory requirements.
- ESD prevention methods need to be followed for manual handling and processing by machinery.
- The edge castellation is designed and made for prototyping, i.e. hand soldering purposes only.
- The applicable country regulations and specific environmental regulations must be observed.
- Do not disassemble the product. Evidence of tampering will void the warranty.
- The temperature rise of the component must be taken into consideration. The operating temperature is comprised of ambient temperature and temperature rise of the component. The operating temperature of the component shall not exceed the maximum temperature specified.

These cautions and warnings comply with the state of the scientific and technical knowledge and are believed to be accurate and reliable. However, no responsibility is assumed for inaccuracies or incompleteness.

All topics are described in a more detailed manner in the user manual for each product.

  	CHECKED RaSi	REVISION 001.000	DATE (YYYY-MM-DD) 2022-04-11	GENERAL TOLERANCE DIN ISO 2768-1m	PROJECTION METHOD 	
	DESCRIPTION WIRL-CLTI Adrastea-I LTE-Cat.M and NB-IoT module				ORDER CODE 2615011136000	
 WÜRTH ELEKTRONIK MORE THAN YOU EXPECT	Würth Elektronik eiSos GmbH & Co. KG EMC & Inductive Solutions Max-Eyth-Str. 1 74638 Waldenburg Germany Tel. +49 (0) 79 42 945 - 0 www.we-online.com eiSos@we-online.com			BUSINESS UNIT eiSmart	STATUS Valid	PAGE 7/8
	This electronic component has been designed and developed for usage in general electronic equipment only. This product is not authorized for use in equipment where a higher safety standard and reliability standard is especially required or where a failure of the product is reasonably expected to cause severe personal injury or death, unless the parties have executed an agreement specifically governing such use. Moreover Würth Elektronik eiSos GmbH & Co KG products are neither designed nor intended for use in areas such as military, aerospace, aviation, nuclear control, submarine, transportation (automotive control, train control, ship control), transportation signal, disaster prevention, medical, public information network etc... Würth Elektronik eiSos GmbH & Co KG must be informed about the intent of such usage before the design-in stage. In addition, sufficient reliability evaluation checks for safety must be performed on every electronic component which is used in electrical circuits that require high safety and reliability functions or performance.					

Important Notes

The following conditions apply to all goods within the product range of Würth Elektronik eiSos GmbH & Co. KG:

1. General Customer Responsibility

Some goods within the product range of Würth Elektronik eiSos GmbH & Co. KG contain statements regarding general suitability for certain application areas. These statements about suitability are based on our knowledge and experience of typical requirements concerning the areas, serve as general guidance and cannot be estimated as binding statements about the suitability for a customer application. The responsibility for the applicability and use in a particular customer design is always solely within the authority of the customer. Due to this fact it is up to the customer to evaluate, where appropriate to investigate and decide whether the device with the specific product characteristics described in the product specification is valid and suitable for the respective customer application or not.

2. Customer Responsibility related to Specific, in particular Safety-Relevant Applications

It has to be clearly pointed out that the possibility of a malfunction of electronic components or failure before the end of the usual lifetime cannot be completely eliminated in the current state of the art, even if the products are operated within the range of the specifications. In certain customer applications requiring a very high level of safety and especially in customer applications in which the malfunction or failure of an electronic component could endanger human life or health it must be ensured by most advanced technological aid of suitable design of the customer application that no injury or damage is caused to third parties in the event of malfunction or failure of an electronic component. Therefore, customer is cautioned to verify that data sheets are current before placing orders. The current data sheets can be downloaded at www.we-online.com.

3. Best Care and Attention

Any product-specific notes, cautions and warnings must be strictly observed. Any disregard will result in the loss of warranty.

4. Customer Support for Product Specifications

Some products within the product range may contain substances which are subject to restrictions in certain jurisdictions in order to serve specific technical requirements. Necessary information is available on request. In this case the field sales engineer or the internal sales person in charge should be contacted who will be happy to support in this matter.

5. Product R&D

Due to constant product improvement product specifications may change from time to time. As a standard reporting procedure of the Product Change Notification (PCN) according to the JEDEC-Standard inform about minor and major changes. In case of further queries regarding the PCN, the field sales engineer or the internal sales person in charge should be contacted. The basic responsibility of the customer as per Section 1 and 2 remains unaffected.

6. Product Life Cycle





Due to technical progress and economical evaluation we also reserve the right to discontinue production and delivery of products. As a standard reporting procedure of the Product Termination Notification (PTN) according to the JEDEC-Standard we will inform at an early stage about inevitable product discontinuance. According to this we cannot guarantee that all products within our product range will always be available. Therefore it needs to be verified with the field sales engineer or the internal sales person in charge about the current product availability expectancy before or when the product for application design-in disposal is considered. The approach named above does not apply in the case of individual agreements deviating from the foregoing for customer-specific products.

7. Property Rights

All the rights for contractual products produced by Würth Elektronik eiSos GmbH & Co. KG on the basis of ideas, development contracts as well as models or templates that are subject to copyright, patent or commercial protection supplied to the customer will remain with Würth Elektronik eiSos GmbH & Co. KG. Würth Elektronik eiSos GmbH & Co. KG does not warrant or represent that any license, either expressed or implied, is granted under any patent right, copyright, mask work right, or other intellectual property right relating to any combination, application, or process in which Würth Elektronik eiSos GmbH & Co. KG components or services are used.

8. General Terms and Conditions

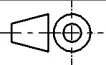
Unless otherwise agreed in individual contracts, all orders are subject to the current version of the "General Terms and Conditions of Würth Elektronik eiSos Group", last version available at www.we-online.com.

  			CHECKED RaSi	REVISION 001.000	DATE (YYYY-MM-DD) 2022-04-11	GENERAL TOLERANCE DIN ISO 2768-1m	PROJECTION METHOD 	
 WÜRTH ELEKTRONIK MORE THAN YOU EXPECT						DESCRIPTION WIRL-CLTI Adrastea-I LTE-Cat.M and NB-IoT module		
						ORDER CODE 2615011136000		
Würth Elektronik eiSos GmbH & Co. KG EMC & Inductive Solutions Max-Eyth-Str. 1 74638 Waldenburg Germany Tel. +49 (0) 79 42 945 - 0 www.we-online.com eiSos@we-online.com						BUSINESS UNIT eiSmart	STATUS Valid	PAGE 8/8